

SIRUBA®

銀箭牌工業用縫紉機
INDUSTRIAL SEWING MACHINE



visit us at <http://www.siruba.com/>



BH790 SERIES

Computer-controlled high-speed lockstitch buttonholing machine



BH790

-

A

机种别
Model

高速电子平缝锁眼机
Computer-controlled, high-speed, lockstitch
buttonholing machine

编号 Code	用途 Application
A	平织类衣物的钮扣孔锁眼用，如衬衫、工作服、女装等。 Buttonholing of woven cloth such as shirts / blouses, work uniforms, ladies' wear, etc.
B	针织类衣物的钮扣孔锁眼用，如针织内衣、毛衣、运动服等 Buttonholing of knitting cloth such as underwear / jerseys, sweaters / cardigans, sportswears, etc.

STANDARD SEWING PATTERN LIST

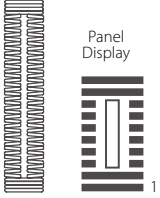
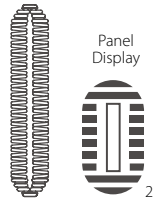
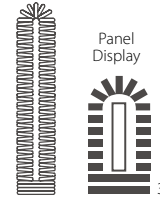
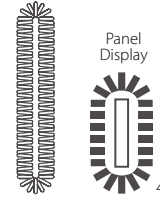
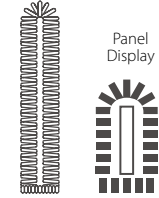
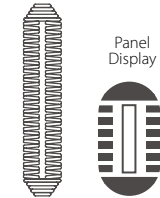
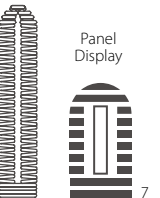
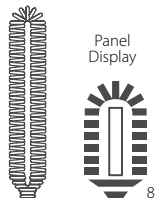
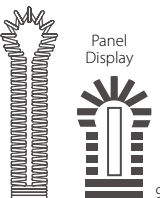
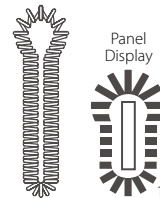
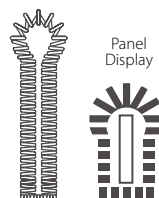
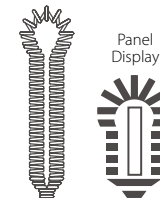
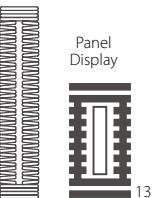
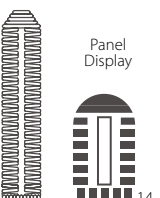
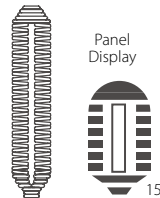
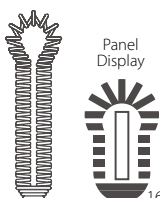
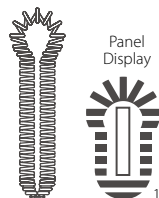
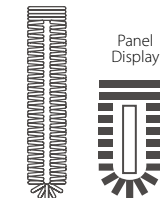
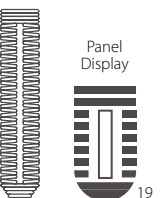
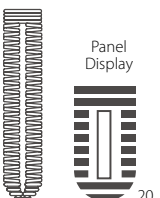
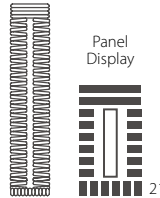
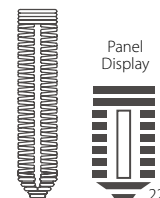
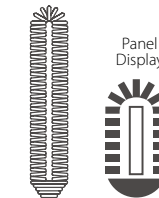
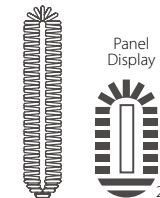
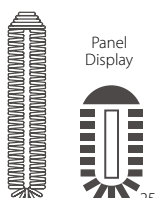
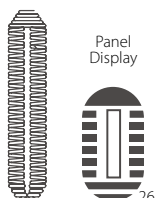
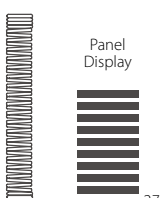
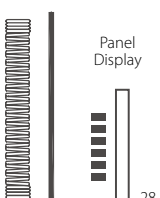
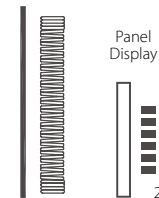
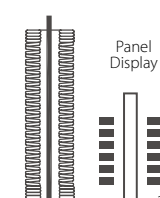
<p>1 角型 Square Type</p> 	<p>2 圆型 Round Type</p> 	<p>3 辐射角型 Radial Square Type</p> 	<p>4 辐射型 Radial Type</p> 	<p>5 辐射直线加固型 Radial Straight Bar-tacking Type</p> 	<p>6 半月型 Semilunar Type</p> 
<p>7 圆角型 Round Square Type</p> 	<p>8 辐射流动加固型 Radial Taper Bar-tacking Type</p> 	<p>9 圆头扣眼角型 Eyelet Square Type</p> 	<p>10 圆头扣眼辐射型 Eyelet Radial Type</p> 	<p>11 圆头扣眼直线加固型 Eyelet Straight Bar-tacking Type</p> 	<p>12 圆头扣眼流动加固型 Eyelet Taper Bar-tacking Type</p> 
<p>13 直线角型 Square Straight Type</p> 	<p>14 半月直线加固型 Semilunar Straight Bar-tacking Type</p> 	<p>15 半月流动加固型 Semilunar Taper Bar-tacking Type</p> 	<p>16 圆头扣眼半月型 Eyelet Semilunar Type</p> 	<p>17 圆头扣眼圆型 Eyelet Round Type</p> 	<p>18 角辐射型 Square Radial Type</p> 
<p>19 角半月型 Square Semilunar Type</p> 	<p>20 角圆型 Square Round Type</p> 	<p>21 角直线加固型 Square Straight Bar-tacking Type</p> 	<p>22 角流动加固型 Square Taper Bar-tacking Type</p> 	<p>23 辐射半月型 Radial Semilunar Type</p> 	<p>24 辐射圆型 Radial Round Type</p> 
<p>25 半月辐射型 Semilunar Radial Type</p> 	<p>26 半月圆型 Semilunar Round Type</p> 	<p>27 加固缝 Bar-tacking</p> 	<p>28 加固右切断 Bar-tacking, Right Cut</p> 	<p>29 加固左切断 Bar-tacking, Left Cut</p> 	<p>30 加固中央切断 Bar-tacking, Center Cut</p> 

TRIMMER GAUGE

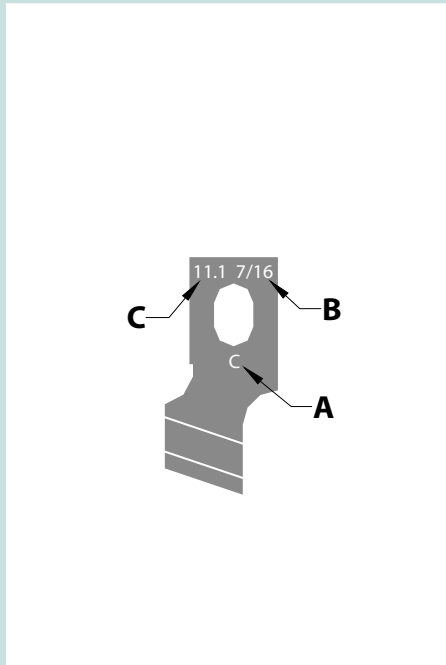

A : 零件代号 A : Parts number	B : 切布刀尺寸(英寸) B : Trimmer size (inch)	C : 切布刀尺寸(mm) C : Trimmer size (mm)
BL724A	1/4	6.4
BL724B*	3/8	9.5
BL724C	7/16	11.1
BL724D*	1/2	12.7
BL724E	9/16	14.3
BL724F*	5/8	15.9
BL724G	11/16	17.5
BL724H	3/4	19.1
BL724I	7/8	22.2
BL724J*	1	25.4
BL724K	1-1/4	31.8

NEEDLE PLATE GAUGE

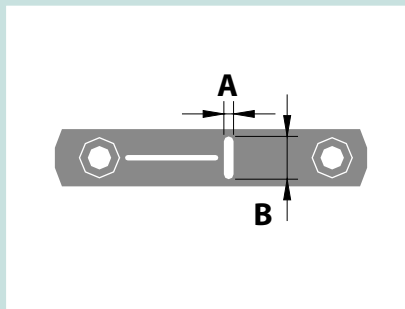

摆动幅度 Sewing range		5mm	6mm
零件规格 Parts no.	平织类用 Wovenwear	E201A*	E202A
	尺寸 Size (A X B) /mm	1.4x6.2	1.4x7.4
	针织类用 Knitwear	E201B*	E202B
	尺寸 Size (A X B) /mm	1.2x6.2	1.2x7.4

PRESSER FOOT GAUGE

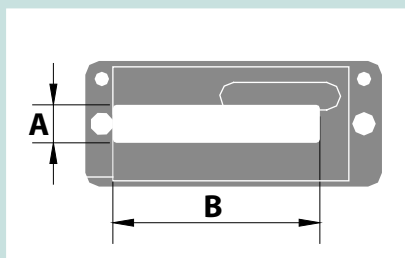

摆动幅度 Sewing range		5mm			6mm
零件规格 Parts no.	平织类用 Wovenwear	P570A*	P571A*	P572A	P573A
	针织类用 Knitwear	P570B*	P571B*	P572B	-
	尺寸 Size (A X B) /mm	4 x 25	5 x 35	5 x 41	6 x 41

「*」为随车标准配件
「*」 is the enclosed standard attachment.

CHARACTERISTICS

ELECTRONICALLY CONTROLLED MAIN DRIVE MECHANISMS

电子控制的主要驱动机构

所采用的电子控制装置可以控制送料、摆针、上切线、下切线、切布刀、以及抬压脚等机构。

An electronic control feature has been adopted for the fabric feeding mechanism, needle swinging mechanism, needle thread trimming mechanism, bobbin thread trimming mechanism, cloth cutting mechanism, and presser foot lifting mechanism.



UNIQUE DESIGN OF OIL STAINS FREE

无油污设计

通过先进的针杆无油式技术，除了旋梭部分以外皆无需加润滑油，此成果消除缝制品被油污污染的问题。

Through advanced semi-dry technology, no lubrication is required except for the hook section. This achievement eliminates oil stains on the sewing products.



CONTROL PANEL

操作面板

数位化的操作及调整，可由液晶面板显示设定或储存。

The digitalized operations and adjustments enable the LCD panel to display or store the setting.



THREAD BREAKING DETECTOR

断线检知

车缝中断线立刻停止，可退针接缝，不需要重新车缝。

If the breaking happened during sewing, the sewing can be stopped immediately. After threading and adjusting backward key on control panel, the needle will return to continue sewing. The sewing doesn't need to be restarted.



OPERATION SPACE

操作空间

机臂到针头的距离加长，且落针点左侧的宽度大幅缩减。此设计有助于缝制布料的置放，因此可以确认工作效能的提升。

The distance from the machine arm to the needle has been lengthened and the left side section of the needling point has been reduced by a large margin. This helps in the smooth placement of the sewing materials on the machine, thereby ensuring the improvement of production efficiency.



MOTOR DRIVEN PRESSER FOOT LIFTER (OPTIONAL)

马达驱动抬压脚 (选配)

抬压脚由脉冲马达驱动，利用脚踏板控制，调整压脚的抬升高度。

The presser foot lifter is driven by the pulse motor. Use pedal to adjust the lifting height of presser foot.



机型 Model	BH790-A	BH790-B
缝纫速度 Sewing speed	最高3600 rpm Max. 3600rpm	
针棒行程 Needle bar stroke	34.6mm	
套结宽幅 Bar-tacking Width	标准5mm / 最大6mm standard 5mm / max. 6mm	
锁眼缝长度 Bar-tacking Length	最大41mm max. 41mm	
使用机针 Needle	DP×5#11~#14	
使用旋梭 Hook	DP型全旋转旋梭 DP Type full-rotary hook	
压脚提升量 Lift of presser foot	14mm	
标准缝制形状 Standard sewing pattern	30个图案 30 patterns	
记忆图案数 Number of patterns stored in memory	99个图案 99 patterns	
切刀规格 Cloth trimmer size	6.4mm(1/4")~31.8mm(1-1/4") A~K(11种)	
切刀驱动方式 Cloth trimmer drive method	双向电磁铁驱动 By 2-way solenoid	
机头驱动方式 Machine head drive method	AC伺服马达(直接驱动) AC servo motor (Direct Drive Type)	